

SHARP

MX-3640N MX-3140N MX-2640N

Digital Full Colour Multifunction System



The Intuitively Easy Way to Put Advanced MFD Functions at Your Fingertips



COPY

NETWORK PRINT

NETWORK SCAN

SHARPEDESK

FAX
OPTION

Add a Touch More Efficiency

For effortless touch control and easy efficiency, the MX-3640N/3140N/2640N puts advanced MFD functions at your fingertips via a 10.1-inch colour LCD touchscreen. Fast, top-quality colour copying, convenient network scanning, a handy Advanced Preview function, and more are only a few simple finger gestures away. As a next-generation workhorse, the MX-3640N/3140N/2640N supports productivity-boosting options for document management and finishing, Internet browsing, and Sharp OSA (Open Systems Architecture) while also delivering outstanding energy efficiency and reliable data protection.

Sharpdesk Mobile—Keeping Pace with the Way You Work

As document demands increasingly move from out behind the desk to wherever business takes you, Sharpdesk Mobile*—an easy-access mobile print/scan application that connects Sharp MFDs to popular mobile devices via a wireless LAN connection—can help you keep pace. Documents scanned on a Sharp MFD can be sent to a mobile device running iOS or Android™ OS to preview and save. Documents saved on a mobile device can be printed out on the MFD, sent as e-mail attachments, or used in other applications. By combining the efficiency of Sharp MFDs and the convenience of mobile devices, Sharpdesk Mobile is adapting document usage to today's changing work styles. It's evolutionary!

* For details, see page 9.

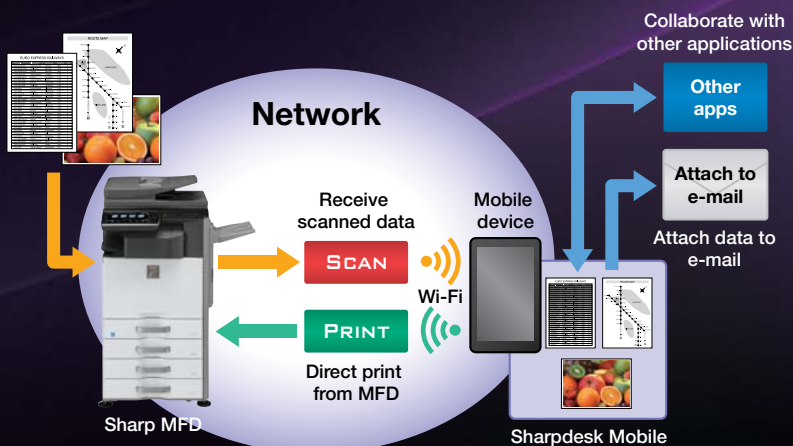

Web Brow

A Web browsing option adds full In viewing and printing out Web page the MX-3640N/3140N/2640N' s LC

Choice of Screen Style

The MX-3640N/3140N/2640N offers a choice of six LCD screen colours (black, blue, warm grey, green, orange, and pink) and a universal-design screen. While the default colour is black, users can easily select their preferred background style.

Breathtaking Image Quality

Sharp's second-generation high-grade toner and an improved imaging system combine to allow the full spectrum of colour reproduction in crisp, sharp detail. The MX-3640N/3140N/2640N delivers fast, high-resolution copying and printing to render text documents, photographs, illustrations, maps, and graphs—including fine lines and small print—with breathtaking precision and clarity. The MX-3640N/3140N/2640N is so easy to operate, superb-quality images are always just a touch away.

Auto Colour Mode



Original

Auto recognition

Text comes out crisp and clear, and unnecessary background colour is automatically removed

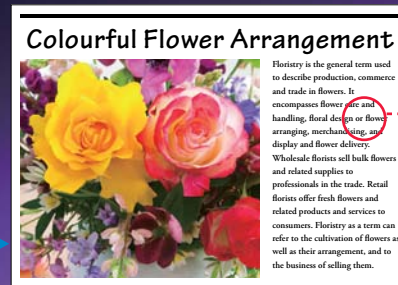

Copy

are and
gn or flowe
ising, and



Enhanced Intuitive Operation

Simple hand gestures and a 10.1-inch colour LCD touchscreen let even first-time users navigate the MX-3640N/3140N/2640N with ease. Thanks to newly added multi-touch operation, two-finger pinch and spread gestures facilitate Web browsing and make it easy to shrink and enlarge images in Advanced Preview. Equally easy one-touch commands, such as flick, drag, and tap, provide quick onscreen access to MFD functions and ultra-smooth intuitive operation.

...sing
Internet access for
...s and PDF files via
...D—without using a PC.



One-page preview



Thumbnail preview



Basic screen



3D preview



Edit mode

COPYING & NETWORK PRINTING



PRODUCTIVE

Super-Efficient Colour and B/W Output

The MX-3640N/3140N/2640N delivers a fast output of **36/31/26 cpm/ppm*** in B/W and in full colour. The first copy comes out in just **5.2/5.8/5.9 seconds** in B/W and **6.8/7.9/8.1 seconds** in full colour to save valuable time when performing multiple short-run jobs.

* A4, long-edge feeding

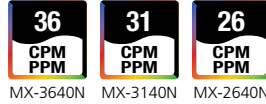

Built-In Duplex Module and RSPF

The MX-3640N/3140N/2640N's built-in stackless duplex module can make **two-sided copies and printouts**, effectively reducing paper costs as well as saving filing space. Duplex copying is even more effective when the duplex module is used together with the standard-equipped **100-sheet RSPF** (reversing single pass feeder), which efficiently feeds in one or two-sided originals and can also simultaneously scan paper of different sizes. With a scanning speed of **50 opm** (originals per minute) for both colour and B/W documents, the MX-3640N/3140N/2640N can complete large jobs with ease and efficiency.

Automated Finishing

The MX-3640N/3140N/2640N automates time-consuming finishing tasks and makes it easy to create professional-looking booklets. The **Saddle Stitch Finisher** option staples documents up to 50 sheets and can fold and staple sets of documents up to 15 sheets to make completed booklets. A space-efficient **Finisher** option is available for jobs that require sorting and stapling. An optional **Punch Module** allows you to punch holes in documents for easy filing.



Extra Paper Capacity

For high-volume work, the MX-3640N/3140N/2640N can accommodate an optional **stand with 500 + 2,000-sheet paper drawers** for a total capacity of **6,600 sheets**. When a tray runs out of paper, the **Auto Tray Switching** function automatically switches to another paper tray filled with the same size paper, allowing you to do extra-large volume jobs without worry.



Supports Most Office Environments

The MX-3640N/3140N/2640N works with the latest and most commonly used versions of Windows®, Windows Server®, and Mac operating systems and network protocols—including **IPv6**—even in mixed OS environments. You get fast, powerful network printing via the 1000Base-T **Gigabit Ethernet** standard.

A Range of Copy/Print Applications

Multi Shot and Booklet Making

Thanks to Multi Shot, two to eight pages of a multi-page document can be copied and up to 16 pages can be printed onto a single sheet, reducing paper use. Also with the optional Saddle Stitch Finisher, multiple sheets can be automatically centre-stapled together to make booklets.

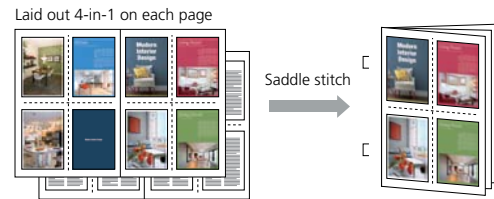

Custom Images

Customised images prepared by the user, such as a company logo stamp or a "TOP SECRET" watermark, can be used on copies.

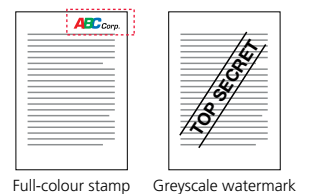

Book Divide

When copying or scanning a booklet or book, the Book Divide function separates the right and left (or the top and bottom) of a two-page spread and outputs each page in the original page order.

Image Positioning

With this function, a scanned image, such as a photo or an illustration, can be copied onto another document in a position specified by the user. The output can be confirmed beforehand using the Advanced Preview function on the LCD.

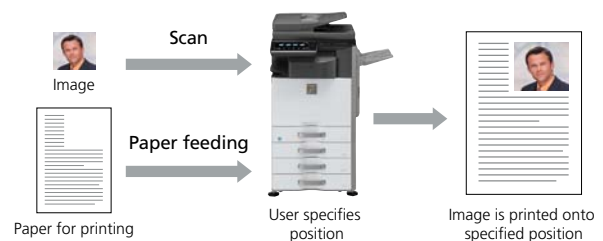

Long-Paper (Banner) Printing*

The optional **Long Paper Feeding Tray** accommodates extra-long paper up to **1,200 mm**—expanding the range of print products to include panoramic pictures, large display-window ads, banner signs, and more.

* Contact a Sharp customer representative for details on using this function.



(Image)

SUPERB IMAGE QUALITY

Improved Imaging System

Sharp thoroughly revamped its imaging process for the MX-3640N/3140N/2640N; now a high-performance processor, a new developer, and the **second-generation high-grade toner** combine to provide breathtaking image quality. The new toner expands the colour reproducibility range for a more natural rendering of clear blue skies, emerald green oceans, and other colour images. The smaller particle size of the toner and the developer allows for reduced graininess and clear reproduction of fine lines, fine text, and halftone colours.

High-Resolution Output

The MX-3640N/3140N/2640N delivers 600-dpi copying and razor-sharp **1,200-dpi** printing—without sacrificing output speed. Digital smoothing technology enhances the print and copy resolution to the equivalent of **9,600 x 600 dpi** for incredibly smooth reproduction of fine lines. Fine-grained photographs, detailed illustrations and graphs, and small text come out crisp and clear.

Easy, High-Quality Copying

Built to deliver automated, high-quality copying, the MX-3640N/3140N/2640N can reproduce maps with crisp, clear text and can remove unnecessary background colour from newspaper and magazine copies. Here's how it works: **Auto Colour Mode** analyses the contents of each page to distinguish between different components, such as photos and text, and then selects the appropriate copy mode for that page. **Auto Colour Selection** automatically determines whether a page is colour or B/W and then copies that page accordingly. **Auto Exposure** automatically removes unnecessary background colour for clearer output.

Adobe® PostScript® 3™

The MX-3640N/3140N/2640N supports genuine Adobe PostScript 3 for better graphics handling.

VERSATILE OPERATION

Direct Printing*1

The MX-3640N/3140N/2640N can print PDF, TIFF, JPEG, and XPS*2 files without using the printer driver. There is also a USB port beneath its control panel, which comes in handy when printing data directly from USB memory devices—an indispensable function for users who are in a hurry or who want quick machine access without a PC.

*1: Direct printing may not support all PDF, TIFF, JPEG, and XPS formats.
*2: Direct XPS printing requires optional MX-PUX1.



Simultaneous Job Processing

The MX-3640N/3140N/2640N makes it easy to simultaneously carry out multiple jobs. Scanned documents can be copied and e-mailed at the same time. Documents can be simultaneously printed and faxed for ultra-convenient multitasking.

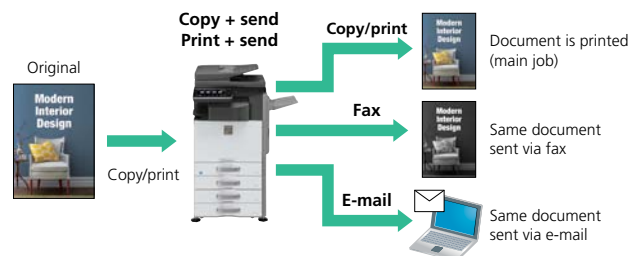

Other Key Features

Heavy-Paper Handling

The MX-3640N/3140N/2640N can handle heavy paper up to **300 g/m²**, further expanding the range of printing applications.

Repeat Layout

Upgraded from the conventional Photo Repeat function, this function can repeat an entire page layout as a single image onto a single sheet.

Auto Zoom for Irregular-Size Originals

With Auto Zoom, after the user specifies the required finished size of a copy, the MX-3640N/3140N/2640N will automatically calculate the appropriate ratio by which to reduce or enlarge an irregular-size original.

Layout Print

This function repeats an entire page layout as a single image. The user can specify whether or not to repeat the first page (cover page) of the document.

- **Tab Copy / Tab Print** can copy or print directly onto tabs on document separators and insert them into assigned positions.
- **Multi-Page Enlargement** divides an image onto separate sheets for copying/printing posters.
- **Carbon Copy Print** mode automatically outputs multiple printouts of the same data on plain and/or coloured paper; convenient for invoices and purchase orders.
- **Form Overlay** can store office document formatting such as letterheads and overlay contents in colour, eliminating the need for pre-printed paper.
- **Barcode font** compatibility (requires optional MX-PF10)
- **Card Shot** enables easy copying of both sides of a card (credit cards, ID cards, etc.) onto a single page.
- **Colour Stamp** labels your copies with page numbers, the date or text such as "Urgent" in up to four different colours.
- **Book Copy** is convenient for compiling copies of a book or bound originals into pamphlet format.



IMAGE SENDING

: Scan : Fax

A3 Colour Network Scanning

The MX-3640N/3140N/2640N works as a **full-colour network scanner** and supports TIFF, PDF, PDF/A, encrypted PDF, compact PDF*, JPEG, and XPS file formats. Converting any type of paper-based document, up to A3 in size, into an editable digital file is as easy as making a copy. Enhanced scan performance improves the legibility of extremely fine text and allows vivid colour reproduction in scanned documents. **Auto Colour Selection** chooses the right mode for scanning originals containing both colour and B/W pages (see page 4). Five levels of sharpness and contrast control enable finely tuned adjustments for optimal image quality.

* Requires optional MX-EB11.

Multiple Distribution of Scanned Files

With just a few taps on the LCD touchscreen, you can choose different ways to distribute your scanned documents. **Scan to E-mail** sends documents as an e-mail attachment. **Scan to FTP Server** scans documents directly to an FTP server for storage. **Scan to Desktop** sends scanned documents directly to your PC desktop. **Scan to Network Folder (SMB)** sends files to a shared folder on a networked Windows PC. **Scan to External Memory Device** scans documents directly to USB memory devices. **Scan to Fax** enables conventional faxing or Internet faxing.

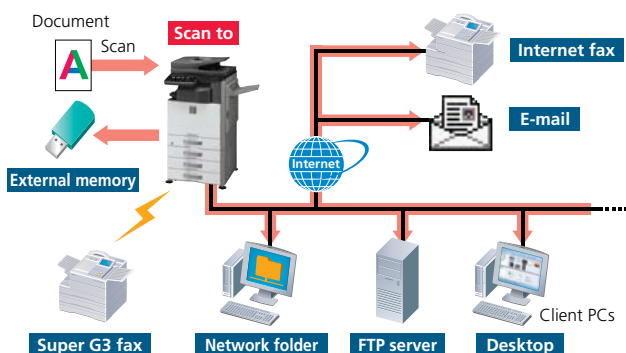

Home Directory

The Home Directory function with user authentication allows users to designate a network folder as their own default scan destination, enabling easy data transfer. In addition to simplifying the scanning process, this handy function lets users scan and send large files that exceed the capacity of mail servers. It's so simple: after a user has logged on via user authentication and gone to the Image Send screen, the Home Directory function automatically selects the scan-destination folder.

One Scan/Multi Format

This function allows you to specify image resolution or colour for each mode of broadcasting employed. For example, when sending the same image data to both a fax and an e-mail destination, you can send a B/W version via fax and a full-colour version via e-mail.

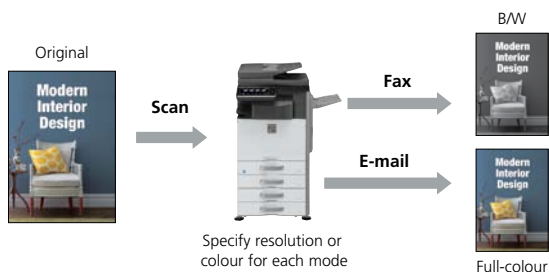

LDAP Support

Built-in LDAP (lightweight directory access protocol) support eliminates the need to enter or register full addresses. When you enter the first few letters of the recipient's name, the MX-3640N/3140N/2640N displays a list of possible matches from your company's LDAP server. Selected addresses can be stored to the MX-3640N/3140N/2640N's address book.

Drop Out Colour

This function removes chromatic colour from a scanned image, reducing the data size for compact storage and enhancing the legibility of B/W text to improve the text recognition rate before OCR.

Black Letter Emphasis

When text-heavy documents are scanned, this function improves the legibility of B/W text while keeping the file size down. Text is scanned at high resolution while the rest of the document, including photos and illustrations, is scanned at a lower resolution.

Improved Address Book

With the MX-3640N/3140N/2640N's improved address book format, up to seven destinations, including e-mail addresses, fax numbers, and FTP addresses, can be displayed under each registered entry. For enhanced security, when registering an entry, you can select whether the information will be open to all MFD users or limited to only designated users or groups. Since only the viewable addresses for each logged-in user are displayed, the list of addresses is narrowed down, making address searches easier. Note: Contact a Sharp customer representative for details on activating this function.

PC-Fax/PC-Internet Fax

Directly send a document created on your PC to a recipient's fax machine via a phone line or the Internet without printing to paper. Save time and paper costs while retaining original document quality. Note: PC-Internet Fax requires optional MX-FWX1; PC-Fax requires MX-FX11.

Internet Fax

Economically send and receive faxes to and from other T-37-compliant Internet fax machines via the Internet. Thanks to **Direct SMTP** support, outgoing Internet faxes do not go through your mail server, making transmission faster and cheaper. Note: Requires optional MX-FWX1.

Paperless Faxing with Inbound Routing

Paperless faxing with inbound routing lets you check incoming faxes via e-mail before printing them out. It can also forward incoming faxes to destinations—another fax/Internet fax machine, an FTP server, a network folder (SMB), or a PC desktop—specified for each sender. When fax data is transferred by file, the Inbound Routing function automatically attaches the fax sender's name (as registered in the MFD's address book) to the file, so recipients will know who sent the fax. Note: PC-Internet Fax requires optional MX-FWX1; PC-Fax requires MX-FX11.

Fax Data Storage on MFD Hard Disk

The MX-3640N/3140N/2640N automatically stores data from incoming and Internet faxes on its hard disk for easy confirmation and printing from a PC. Note: PC-Internet Fax requires optional MX-FWX1; PC-Fax requires MX-FX11.

DOCUMENT MANAGEMENT

Document Management on the Hard Disk

You can save processed job data in designated folders on the MFD's hard disk, making it easy to instantly recall saved documents or jobs for printing and sending at a later time. This contributes greatly to efficient sharing and distribution of information in your business operations.

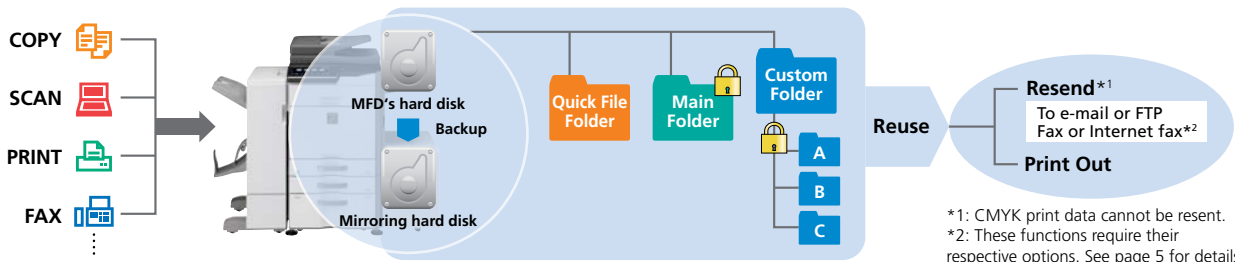

*1: CMYK print data cannot be resent.
*2: These functions require their respective options. See page 5 for details.

Quick Filing

Up to **10,000 pages** or 1,000 files*³ that have been copied, printed, scanned, or faxed can be stored by job on the hard disk in a Quick File Folder. You can easily reuse saved data without having to reload or rescan the original.

Advanced Filing Function

Up to **20,000 pages** or 3,000 files*³ that have been copied, printed, scanned, or faxed*⁴ can be stored by job on the hard disk in up to 1,000 folders with customised names and locations. Enhanced security features require users to enter a 5 to 8-digit password to access secure folders, protecting your sensitive data. Storage options include Main Folder for workgroup sharing and Custom Folder for enhanced-security archiving.

*3: Storage capacity will vary depending on the type of document and the scan settings.
*4: For fax and Internet fax jobs, only transmitted data (not received faxes) can be saved in the Document Filing function.

Easy Access to Stored Files

Documents stored on the hard disk can be quickly and easily searched and accessed from the control panel's LCD via thumbnail displays and file previews or through a Web browser.



Thumbnail displays



Web access screen

File Combining

For more effective data utilisation, two files saved on the MFD's hard disk can be easily combined into one file.

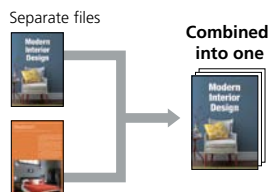

PDFs for PC Browsing

Processed job data can be saved as PDF files for browsing and downloading on a PC.

Easy Sharing of Application Files

To facilitate file sharing across the office network, the MX-3640N/3140N/2640N provides 120GB of hard disk storage space for folders. Each folder can hold up to 500 files created with applications such as Word and Excel® and saved in their original format.

Note: It is advisable to back up data saved to the MFD's hard disk through use of the optional Mirroring Kit.



Document is saved to MFD in original file format

Stored on MFD's hard disk

User retrieves file from MFD

Mirroring Kit

To protect the enhanced data handling capability of the MFD's hard disk, which provides improved Document Filing functions and easy sharing of application files, the optional Mirroring Kit offers hard disk backup and peace of mind.

Sharpdesk for Total Document Management

Sharpdesk is an original Sharp application that provides integrated desktop management of documents in over **200 file formats**, including scanned paper-based documents and those created with popular applications such as Word. With Sharpdesk, documents can be organised, edited, searched, and distributed with simple drag-and-drop operation. Features include **thumbnail** viewing, **annotation** tools for paper-free proofreading, optical character recognition, the ability to combine different types of files into a single document, and more.

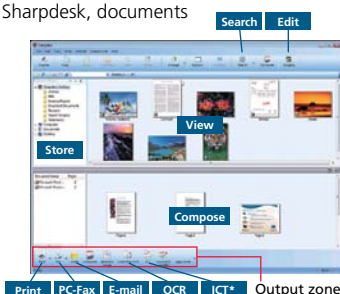

* Image Compression Tool for converting images into compact PDF files

Sharp OSA Network Scanner Tool

This client-based scan-to-desktop option is the ideal document management system for small workgroups or offices that don't have servers. Sharp OSA Network Scanner Tool provides centralised scan/print user profiles to give everyone in the office easy one-touch scanning to their PC from any networked MFD—without complicated settings. Scanned documents can be quickly and easily printed, filed, previewed, shared, and stored to save time and improve document workflow. Sharp OSA Network Scanner Tool automatically names PDF files based on scanned-document titles and can convert scanned documents into text with the OCR engine to create searchable PDF files.

Note: Requires optional MX-AMX2.





MULTI-LAYERED SECURITY

Designed to protect your business assets and bring you peace of mind, Sharp's security solutions employ multiple levels of security functions—both standard equipped and optional—covering a broad range of network and data security needs. The MX-3640N/3140N/2640N safeguards sensitive data with powerful, enhanced security functions that eliminate the worry of unauthorised use and guarantee greater protection for your confidential information.

Data Encryption and Overwriting

Digital copier/printers and MFDs can retain hundreds of pages of confidential information from previous jobs on their hard disks or internal memory. To safeguard such information from unauthorised access, the MX-3640N/3140N/2640N automatically **encrypts** document data stored on the hard disk and in the address book. Standard-equipped security features also provide up to seven automatic **overwrites** of data generated for each job, **protection** of administrator/file/folder passwords, and more.

Note: Contact a Sharp customer representative for details on activating these security functions.

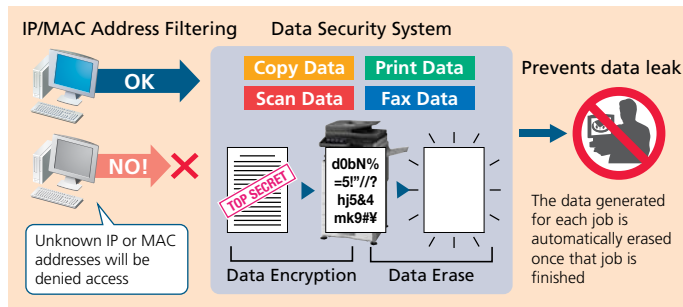

Secure Network Access

The **IP/MAC address filtering** function provides highly secure operation by restricting access to the MFDs on your office network. Only PCs that have either their IP address or MAC (media access control) address registered are allowed to use the MFDs.

Attempted access from an unknown IP or MAC address will be denied, preventing unauthorised use. The MX-3640N/3140N/2640N also supports the **IEEE 802.1X** standard for port-based network access control, which blocks all access from unauthorised devices.

User Authentication

The MX-3640N/3140N/2640N prevents unauthorised use by requiring **passwords** for machine access. This safeguarded solution can register up to 1,000 users in **three access levels** as Administrator, User, or Guest and can designate to which function user authentication applies. The MX-3640N/3140N/2640N can, for example, be set to allow B/W copying by all users while restricting colour copying to designated users. The MX-3640N/3140N/2640N works with an **external Active Directory server** to extend user authentication to multiple MFDs and a greater number of users.

Tracking Information Print

This function prints the MFD user's name, the date, the MFD's serial number, job ID, and other specifics on printouts, making it possible to track documents and prevent data theft.

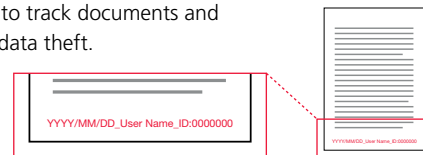

Encrypted PDF with Password Protection

To prevent unauthorised viewing of confidential data, the MX-3640N/3140N/2640N enables scanned PDF data to be password protected and encrypted for transmission over the network. After transmission, viewers can gain access to the encrypted PDF only after re-entering the password.

Hidden Pattern Copy/Print

With this function, a watermark, such as "Confidential" or "Not for Copy," can be embedded onto a document. If that document is copied, the watermark will appear, alerting the user not to distribute it.

Secure Sockets Layer

SSL (secure sockets layer) enables the encryption of data communications to prevent data leakage through the network when printing via IPP, browsing secure Web pages (HTTPS), or communicating via e-mail (SMTP and POP3) or FTP (FTPS).

Document Control Function (option)

Document Control prevents unauthorised copying, scanning, faxing, and filing of confidential documents by embedding copy prevention data onto a document. When that data is detected, any unauthorised attempts to copy will be cancelled or will result in only blank-page output.

Note: Requires optional Data Security Kit. May not work for certain types of documents or paper.

IPv6 and IPsec Support

The MX-3640N/3140N/2640N supports the **IPv6** Internet protocol. An obligatory part of IPv6 is **IPsec** (IP Security), a set of protocols for securing Internet protocol (IP) communications. IPsec encrypts and authenticates traffic between specified parties, giving IPsec-compatible products an extremely high level of network security.

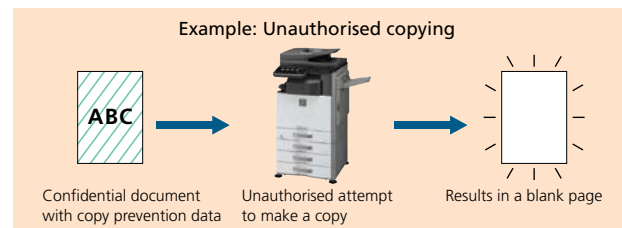

Scan to Me Function

Scan to Me lets a logged-in authorised user send scanned data to his/her own e-mail address simply by pressing the start button. This eliminates the need to manually enter or select the address, thereby preventing documents from being sent to the wrong address.

Data Initialisation

The MX-3640N/3140N/2640N's initialisation function allows confidential information to be erased. Initialising an MFD when it's time to replace it prevents important resources, such as customer information and intellectual property, from leaking out and provides considerable peace of mind.



DEVICE MANAGEMENT

Web-Based System Settings

Administrators can manage every important setting—including user access and security as well as other controls and configurations—through a standard Web browser right from their desktops.

Remote Diagnosis

The MX-3640N/3140N/2640N can be monitored remotely through a Web browser, letting administrators handle tasks before they become problems. When action or maintenance is required, the **E-Mail Status and Alert** function notifies administrators via timely e-mail alerts.

Network Utility Software

Sharp Remote Device Manager* (SRDM) gives administrators centralised control of their networked MFDs through a standard Web browser, making device cloning and other operations easier and more accessible.

* Contact a Sharp customer representative for details on using this function.

Remote Operation

The Remote Operation function lets you display the MFD's main control panel on your PC screen, allowing you to operate every major function directly from your desktop.* This function also enables the administrator to guide an MFD user through necessary procedures and allows remote MFD operation.

* Requires VNC application.



EASE OF USE

10.1-Inch Colour LCD Touchscreen

MFD operation has never been so intuitive, so easy. The MX-3640N/3140N/2640N's control panel features a wide, clear, WVGA-resolution LCD touchscreen. Simple flick, drag, tap, (and more) gestures performed on the screen bring easy control of every document, function, and setting. Dual-touch pinch and spread gestures enable smooth Web browsing and effortless shrinking/enlarging of Advanced Preview images. For strain-free viewing, the MX-3640N/3140N/2640N's user interface employs a bold scalable font in sizes that vary in line with the content on display.

Mode Tabs

Mode tabs at the top of the screen make it easy to change job modes (copy, fax, document filing, Sharp OSA, etc.).



Customisable Screen

The Home screen can be customised for individual users by programming their most frequently used functions and settings, creating **shortcut keys** for quick and easy access, and using logos, icons, background images, and other items prepared by the user. The **Enlarge Display** mode brings added readability.



Advanced Preview

The Advanced Preview function saves you time and effort by displaying scanned images on the LCD for confirmation and editing. Page layout and document finishes such as stapling can be checked before the documents are printed out. Previewed pages can be easily rotated, put in a different order, and deleted via tap-and-drag editing right on the LCD. You can even erase specific parts of a previewed page and insert blank pages.

Action Panel

The Action Panel appears on the right side of the touchscreen to guide you through operational procedures. The MFD intuits what actions to take next and the Action Panel displays shortcut keys and messages pertaining to those actions.

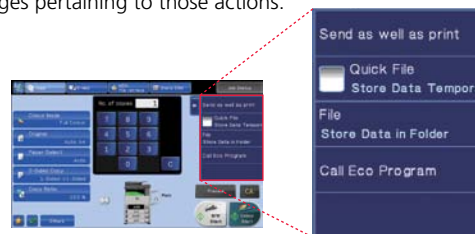

(Screen in Enlarge Display mode)

Other User-Friendly Features

Universal Design

- The control panel can be **tilted** to five different angles* for easy viewing.

* Tilts to only two angles when an optional finisher is installed.

- **Easy-grip handles** allow the paper drawers to be grasped from the top as well as the bottom for easy opening and closing.



Retractable Keyboard (option)

A **full-size retractable QWERTY keyboard** slides out from beneath the control panel to make text input fast and easy.



ENVIRONMENT-FRIENDLY

Outstanding Energy Efficiency

To reduce power consumption, Sharp has applied its advanced technologies across all areas of this MFD, including the hardware, software, electrical system, and supplies. As a result, the MX-3640N/3140N/2640N boasts a low consumption rate.

- Sharp's belt fusing system shortens the MX-3640N/3140N/2640N's warm-up time to **18 seconds**, contributing to reduced overall energy consumption.

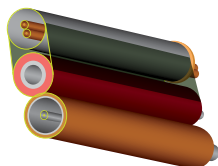

Sharp's belt fusing system

- Based on prior usage patterns, the MX-3640N/3140N/2640N automatically determines the optimal length of time to let elapse before going into **auto power shut-off mode**, helping reduce overall power consumption. Shortly before auto power shut-off mode begins, a message appears* on the LCD indicating that the MFD will soon shut down and giving users the option to continue operation.

* Contact a Sharp customer representative to activate this pop-up message function.

- **Power ON/OFF Schedule** function automatically turns the MX-3640N/3140N/2640N on or off according to time schedules set by the administrator.

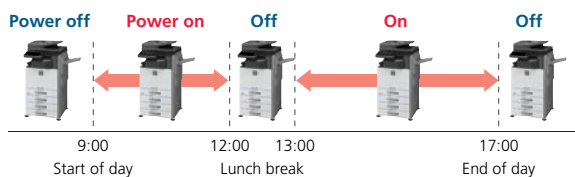

- Before a print*¹/copy command is executed from the control panel, the **Eco Recommendation***² function offers suggestions on environmentally friendly settings, helping users achieve even greater eco-friendly operation.

*1: Printing of Document Filing data and direct printing (FTP/SMB/USB).

*2: Contact a Sharp customer representative for details on activating this function.

- **Eco Scan** function saves energy by keeping the fusing system shut down during jobs that don't require the use of the fusing system, such as Image Sending and Document Filing.
- The second-generation high-grade toner has a **lower melting point** than conventional toner, allowing fusing to be carried out with less energy. It also offers a significantly lower consumption rate than conventional toner.
- For further energy savings, energy-efficient **LED lamps** are employed in the scan unit in place of conventional xenon lamps. A new ASIC (application-specific integrated circuit) also helps the MX-3640N/3140N/2640N deliver excellent performance and energy efficiency.



EXPANDABILITY

Sharp OSA* (Open Systems Architecture)

Innovative Sharp OSA technology allows you to interact with critical business and network applications right from the LCD control panel, offering a new realm of control and convenience. Since Sharp OSA utilises industry-standard network protocols, the MX-3640N/3140N/2640N can easily integrate with document management systems, enterprise resource planning software, workflow applications, and more. The latest version of Sharp OSA can **reach beyond the firewall**, enabling extensive system construction and services over the Internet. Sharp OSA brings benefits such as reducing the costs associated with system implementation and management, as well as enabling data sharing across company branch offices or subsidiaries—effectively enhancing total business efficiency.

* Requires optional MX-AMX2 and/or MX-AMX3.

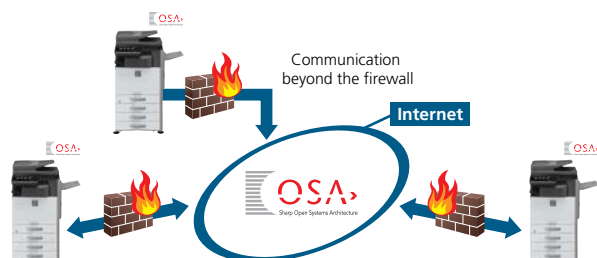

Direct Internet Access

The optional **Web Browsing Expansion Kit** gives you direct access to the Internet for easy browsing of Web sites on the colour touchscreen. With such quick access to information, brochures and user manuals in PDF format as well as maps and coupons can be printed out on the spot.

Sharpdesk Mobile

Sharpdesk Mobile is a mobile print/scan application that combines the convenience of mobile devices and the efficiency of Sharp MFDs to make conducting business on the go easier than ever. Documents scanned on a Sharp MFD can be sent to a mobile device running iOS or Android OS to preview and save. Documents saved on a mobile device can be printed out on the MFD, sent as e-mail attachments, or used in other applications.

Notes on Sharpdesk Mobile:

- This application can be downloaded for free from the Apple App Store for iPad and iPhone or from Google Play™ for Android devices.
- Supported devices: iPhone 4, iPhone 4S, iPad, iPad 2, and iPad (3rd generation) running iOS 4.3, 5.0, 5.1, or 6.0, and Android-based mobile devices running Android 2.3 or 4.0 (SD memory card required for some devices; recommended screen resolution of 800 x 480 pixels or higher).
- Availability varies by country/region. For details, see the Sharpdesk Mobile support Web site: http://sharp-world.com/products/copier/docu_solutions/mobile/sharpdesk_mobile/

OPTIONS

System Configuration

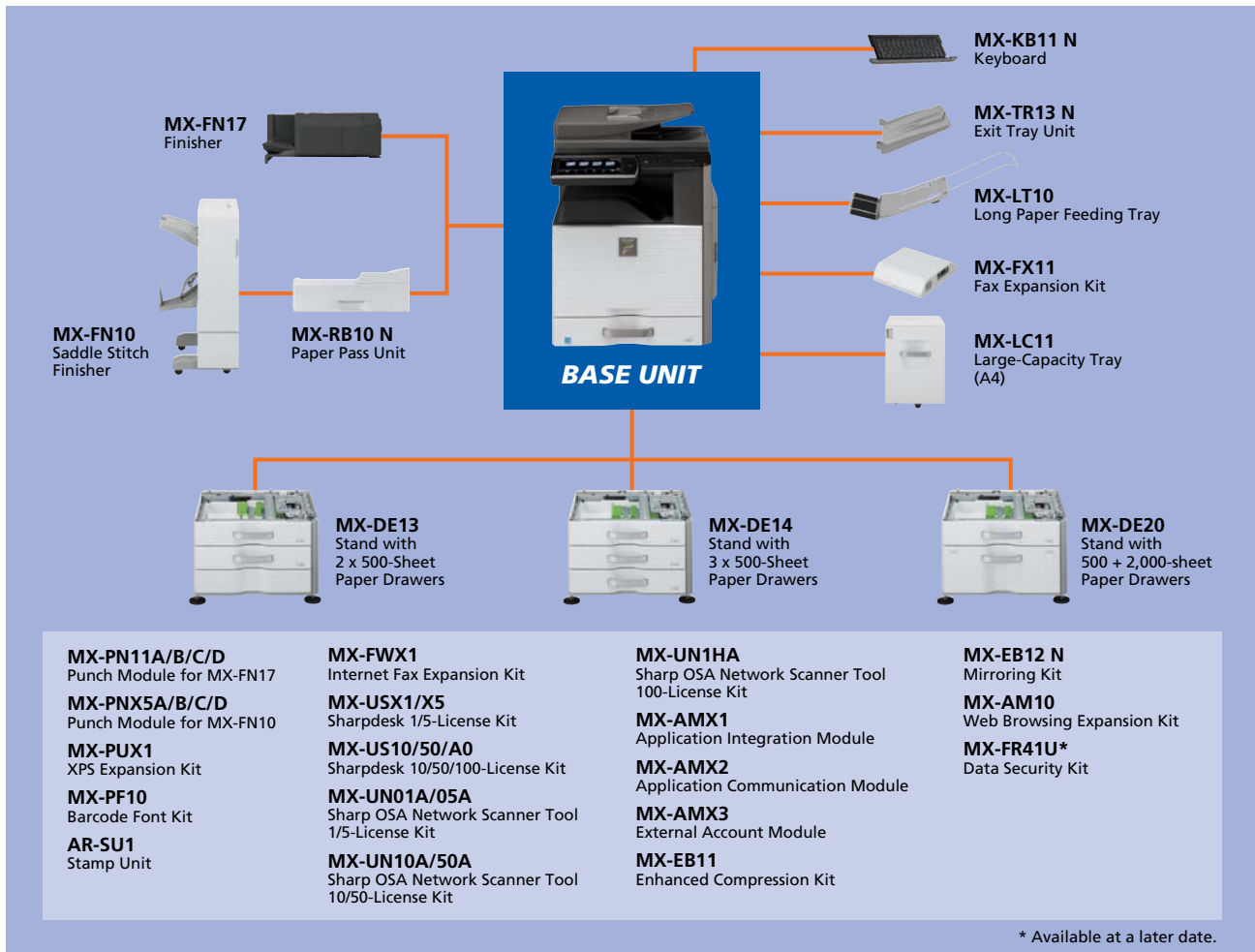

Certain options may not be available in some areas.

Specifications for Options

MX-FN17 Finisher

Paper size	Non offset	A3W to A5R
	Offset/staple	A3 to B5
Paper capacity		500 sheets (A4 or smaller), 250 sheets (B4 or larger)
Stapling capacity		50 sheets (A4 or smaller), 30 sheets (B4 or larger)
Staple position		3 locations (front, rear or both)

MX-FN10 Saddle Stitch Finisher

Paper size	Non offset	A3W to A5R
	Offset/staple	A3 to B5R
Paper capacity	Offset tray	1,000 sheets (A4 or smaller, except A5R), 500 sheets (A5R, B4 or larger)
	Saddle stitch tray	10 sets of 11–15 sheets, 15 sets of 6–10 sheets, 20 sets of 1–5 sheets
Stapling capacity		50 sheets (A4 or smaller), 25 sheets (B4 or larger)
Staple position		3 locations (front, rear or both)

Punch Modules

Model name	For the MX-FN17	MX-PN11A	MX-PN11B	MX-PN11C	MX-PN11D
	For the MX-FN10	MX-PNX5A	MX-PNX5B	MX-PNX5C	MX-PNX5D
Number of holes		2	2/3	4	4 (wide)
Paper weight		55 to 256 g/m ² *			

* Guaranteed punchable weight is 55 to 128 g/m².

MX-FX11 Fax Expansion Kit

Compression method	MH/MR/MMR/JBIG
Communication protocol	Super G3/G3
Modem speed	33,600 bps to 2,400 bps

MX-DE13 Stand with 2 x 500-Sheet Paper Drawers

Paper size (upper and lower tray)	A3 to A5R
Paper capacity (upper and lower tray)	500 sheets each

MX-DE14 Stand with 3 x 500-Sheet Paper Drawers

Paper size (upper/middle/lower tray)	A3 to A5R
Paper capacity (upper/middle/lower tray)	500 sheets each

MX-DE20 Stand with 500 + 2,000-Sheet Paper Drawers

Paper size (upper tray)	A3 to A5R
(lower right/left tray)	A4
Paper capacity (upper tray)	500 sheets
(lower right tray)	850 sheets
(lower left tray)	1,150 sheets

MX-LT10 Long Paper Feeding Tray

Paper size	Max. 1,200 mm long
Paper capacity	1 sheet

MX-LC11 Large-Capacity Tray

Paper size	A4, B5
Paper capacity	3,500 sheets

Note: All specifications relating to paper capacity refer to 80 g/m² paper.

Note: When using Sharpdesk, Sharp OSA Network Scanner Tool, and Sharp OSA, please ask your Sharp representative about PC system requirements.

SPECIFICATIONS

General

Type	Desktop	
Engine speed (colour & B/W)	Max. 36/31/26 cpm/ppm (A4 long-edge feeding)	
Paper size	Max. A3 wide, min. A5R	
Paper capacity (80 g/m ²)	Standard: 600 sheets (500-sheet tray and 100-sheet multi-bypass tray) Maximum: 6,600 sheets	
Paper weight	Tray: 60 g/m ² to 220 g/m ² Multi-bypass tray: 55 g/m ² to 300 g/m ²	
Warm-up time*1	18 sec.	
Memory	Copy/print (shared): 4GB	320GB HDD*2
Power requirements	230-240V AC, 50/60 Hz	
Power consumption (max.)	1.84 kW	
Dimensions (W x D x H)	MX-3640N: 608 x 681 x 834 mm	MX-3140N/2640N: 608 x 659 x 834 mm
Weight (approx.)	76 kg	

Copier

Original paper size	Max. A3	
First copy time*3	[MX-3640N] Full colour: 6.8 sec.	B/W: 5.2 sec.
	[MX-3140N] Full colour: 7.9 sec.	B/W: 5.8 sec.
	[MX-2640N] Full colour: 8.1 sec.	B/W: 5.9 sec.
Continuous copy	Max. 999 copies	
Resolution	Scan (colour): 600 x 600 dpi Scan (B/W): 600 x 600 dpi, 600 x 400 dpi, 600 x 300 dpi Print: 600 x 600 dpi; 9,600 (equivalent) x 600 dpi (depending on print mode)	
Gradation	Equivalent to 256 levels	
Zoom range	25 to 400% (25 to 200% using RSPF) in 1% increments	
Preset copy ratios	10 ratios (5R/5E)	

Network Scanner

Scan method	Push scan (via control panel), pull scan (TWAIN-compliant application)
Resolution	Push scan: 100, 150, 200, 300, 400, 600 dpi Pull scan: 75, 100, 150, 200, 300, 400, 600 dpi 50 to 9,600 dpi via user setting*4
File formats	TIFF, PDF, PDF/A, encrypted PDF, compact PDF*5*6, JPEG*6, XPS*7
Scanner utilities	Sharpdesk, Sharpdesk Mobile*8, Sharp OSA Network Scanner Tool
Scan destinations	Scan to e-mail/desktop/FTP server/network folder (SMB)/USB memory

- *1: At rated voltage, 23°C. May vary depending on operating conditions and environment.
 *2: HDD capacity depends on procurement and sourcing status.
 *3: Long-edge feeding of A4 sheets from 1st paper tray, using document glass, without Auto Colour Selection and Auto Colour mode, MFD in fully ready condition. May vary depending on operating conditions and environment.
 *4: Resolutions higher than 600 dpi are interpolated.
 *5: Optional MX-EB11 required.
 *6: Colour only.
 *7: To view XPS files on PCs not running Windows Vista, you must have the XPS Viewer application installed.
 *8: Availability varies by country/region.
 *9: Storage capacity will vary depending on the type of document and the scan settings.
 *10: Some features require option(s).
 *11: Based on Sharp's standard chart with approx. 700 characters (A4 long-edge feeding) at standard resolution in Super G3 mode, 33,600 bps, JBIG compression.

Document Filing

Document filing capacity*9	Main and custom folders: 20,000 pages or 3,000 files Quick file folder: 10,000 pages or 1,000 files
Stored jobs*10	Copy, print, scan, fax transmission
Storage folders	Quick file folder, main folder, custom folder (max. 1,000 folders)
Confidential storage	Password protection

Network Printer

Resolution	1,200 x 1,200 dpi; 600 x 600 dpi; 9,600 (equivalent) x 600 dpi
Interface	USB 2.0, 10Base-T/100Base-TX/1000Base-T
Supported OS	Windows Server® 2003/2008/2012, Windows® XP, Windows Vista®, Windows® 7/8, Mac OS X10.4, X10.5, X10.6, X10.7, X10.8
Network protocols	TCP/IP (IPv4, IPv6), IPX/SPX (NetWare), EtherTalk (AppleTalk)
Printing protocols	LPR, Raw TCP (port 9100), POP3 (e-mail printing), HTTP, Novell Printserver application with NDS and Bindery, FTP for downloading print files, EtherTalk printing, IPP
PDL (emulation)	Standard: PCL 6 emulation, Genuine Adobe® PostScript® 3™ Option: XPS
Available fonts	80 fonts for PCL, 136 fonts for Genuine Adobe® PostScript® 3™

B/W Facsimile (optional MX-FX11 required)

Compression method	MH/MR/MMR/JBIG
Communication protocol	Super G3/G3
Transmission time	Less than 3 seconds*11
Modem speed	33,600 bps to 2,400 bps with automatic fallback
Transmission resolution	From Standard (203.2 x 97.8 dpi) to Ultra Fine (406.4 x 391 dpi)
Recording width	A3 to A5
Memory	1GB (built-in)
Grey scale levels	Equivalent to 256 levels

- Design and specifications are subject to change without prior notice.
- Colour variations to products may occur due to printing.
- Some features require Optional items. Please consult with an authorised Sharp Reseller for details.
- All information and technical details are correct as at machine release date.
- Windows, Windows Server, Windows Vista, and Excel are registered trademarks of Microsoft Corporation in the United States and/or other countries. Adobe and PostScript 3 are either registered trademarks or trademarks of Adobe Systems Incorporated in the US and/or other countries. App Store is a service mark of Apple Inc. Apple, the Apple logo, iPhone, and iPad are trademarks of Apple Inc., registered in the US and other countries. iOS is a trademark or registered trademark of Cisco Systems, Inc. in the US and other countries and is used under license by Apple Inc. Android and Google Play are trademarks of Google Inc. All other brand names and product names may be trademarks or registered trademarks of their respective owners.
- The ENERGY STAR logo is a certification mark and may only be used to certify products that have been determined to meet the ENERGY STAR programme requirements. ENERGY STAR is a US registered mark. The ENERGY STAR guidelines apply to products only in the US, the EU, Japan, Canada, Australia, New Zealand and Taiwan.

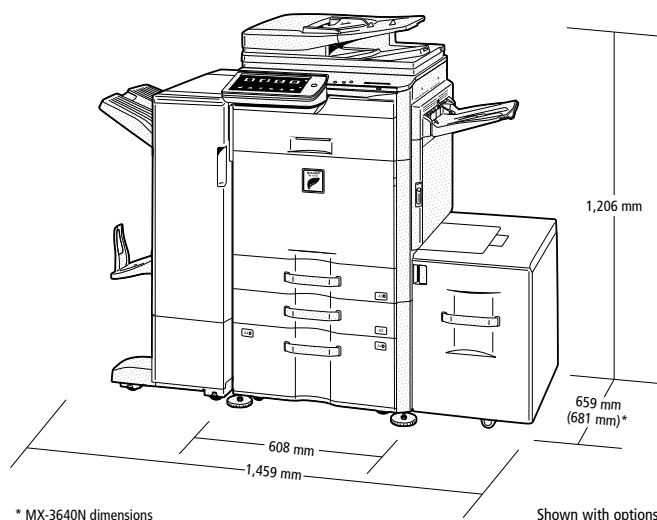

* MX-3640N dimensions

Shown with options.

SHARP

SHARP CORPORATION OF AUSTRALIA PTY LTD
 ABN 40 003 039 405
 1 Huntingwood Drive, Huntingwood NSW 2148
 P.O. Box 6827, Blacktown, NSW 2148
 Tel: (02) 9830 4600 Fax: (02) 9672 1208
 www.sharp.net.au

SHARP CORPORATION OF NEW ZEALAND LTD
 59 Hugo Johnston Drive
 P.O. Box 12244, Penrose, Auckland
 Tel: (09) 573 0111 Fax: (09) 573 0112
 www.sharp.net.nz